



Ultimate System 10 Bevelled Tilt & Turn Windows Technical Specification

JohnFREDERICKS

MANUFACTURERS OF

theultimate[®]
collection

PVC-u Profile

- Halo System 10 70mm bevelled
- Standard outer frame 56mm high / optional 72mm
- Fully welded transoms and mullions
- Steel reinforced to manufacturers specification
- Variable bay poles available plus standard 90°
- Mitred internal bevelled beads (optional ovolo bead)

Colours

- Scan QR code to see our extensive colour range
- Sprayed to RAL colour of choice



Handles

- Standard – White tilt lock and turn handle (enhanced security handle - first locked to the tilt position and for additional security has to be unlocked again for the turn position).
- Optional colours – Black, Chrome, Gold, Bronze, Antique Black, Satin

Locking and Hinge System

- Opening inwards concealed wrap-around tilt before turn gearing. Opening to 90°
- Optional face-mounted tilt before turn gearing Opening to 180° (must be used in conjunction with 72mm large outerframe)

Glass Unit Options

- Standard 28mm double glazed to U value 1.4
- Optional 36mm triple glazed to U value 1.1 (bevelled bead only)
- Black warm edge spacer bar
- Optional White or Grey warm edge spacer bar

Glazing Options

- Clear or patterned glass
- Range of lead lite patterns
- Internal 18mm or 25mm Georgian bar
- Bevelled Ali-lock clip on Georgian bar outside and bevelled or ovolo inside based on bead selection

Ventilation

- When specified 2500/4000 trickle vents can be fitted to the top of the window opener or top of large outer frame
- Optional concealed trickle ventilation canopy (top of large outer frame only)

Accreditations

- BS7412 Weather Performance KM 36014
- PAS24 Enhanced Security KM 36015

Please note: that as an inward opening product and specific handle operation, we do not recommend Tilt and Turn Windows as suitable for fire escape applications. Where required, please seek appropriate guidance from your local authority.

ULTIMATE SYSTEM 10 BEVELLED TILT & TURN WINDOWS - TYPICAL SECTIONS

Inward opening internally beaded | Bevelled profile | All measurements in mm

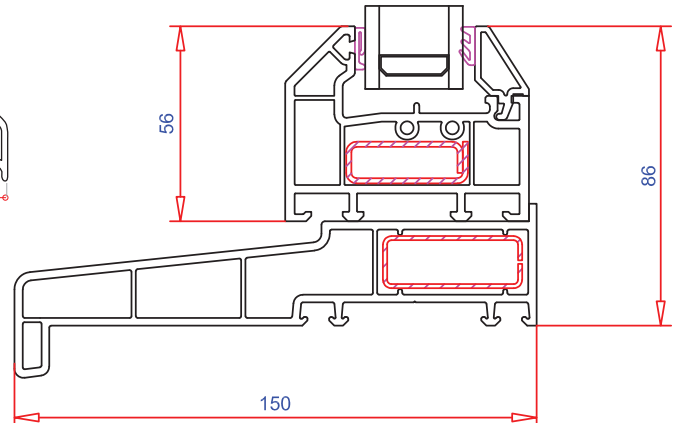
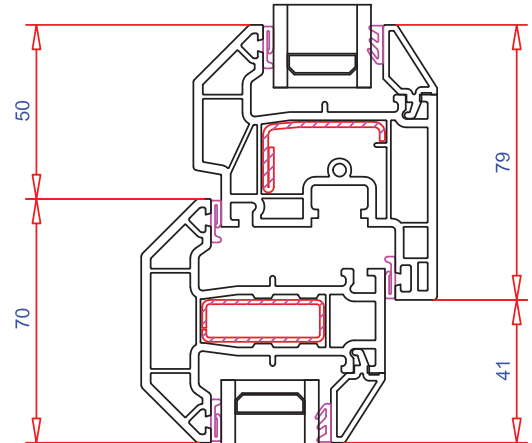
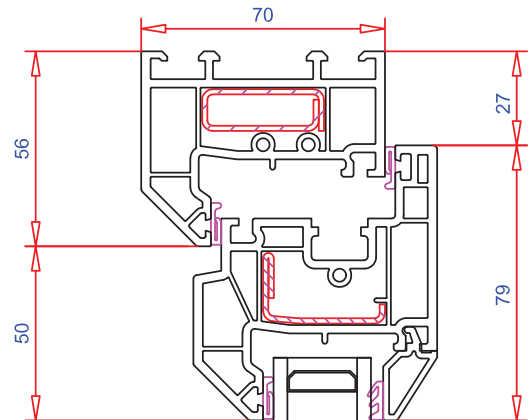
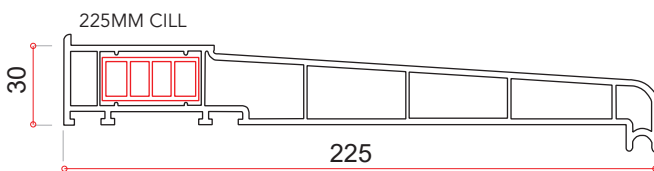
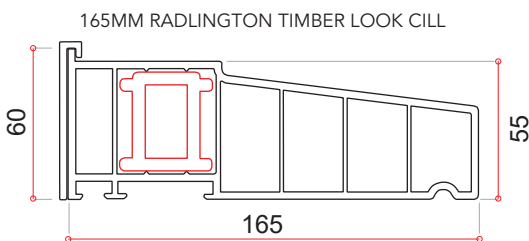
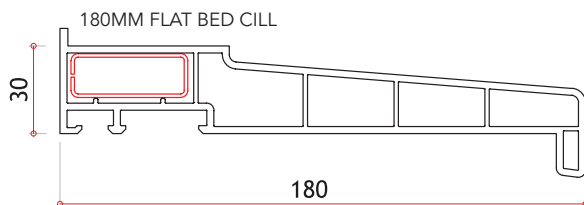
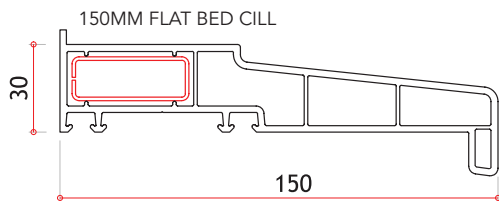
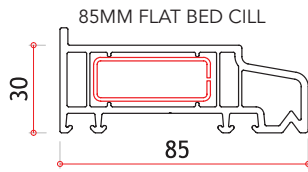

Max width	1394mm	Min width	527mm
Max height	2100mm	Min height	609mm
Max Sash weight	80Kgs		

Notes:

NO T&T to be wider than it is tall, recommended ratio is 2:1 (2 being the height, 1 being the width). Smaller sashes and windows not within the ratio are prone to 'self-closing'.

180° Gearing has different maximum and minimum sizes please contact your sales advisor for further information.